

LH-51E25C

MR16

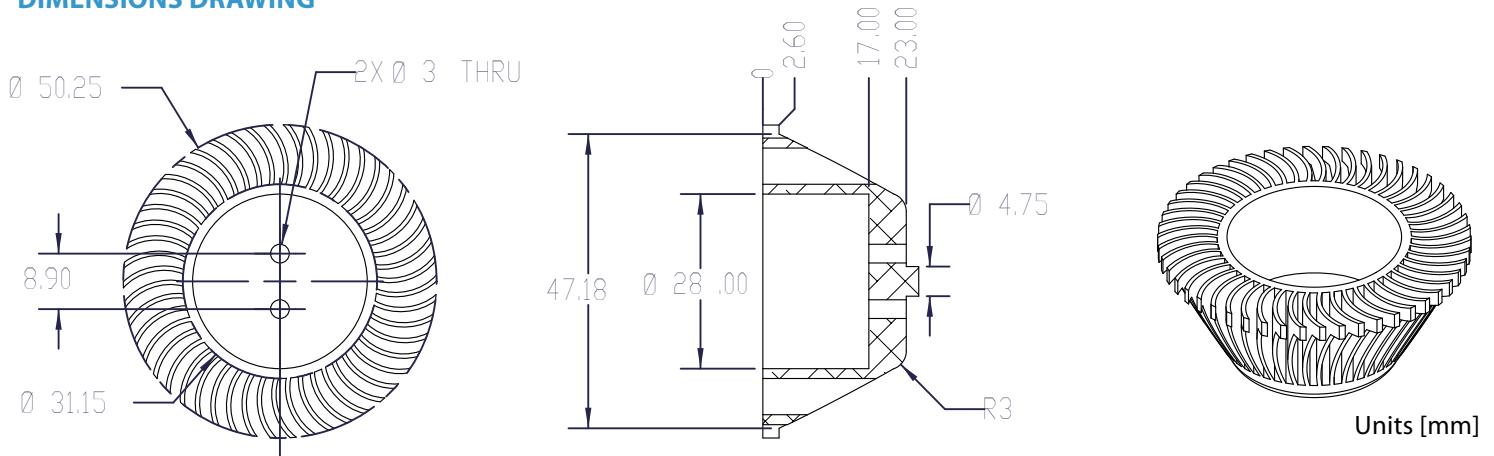

DIMENSIONS DRAWING



Part Number	Dimensions		Material(s)	Surface Finish	Weight [Gram]	Maximum Power [Watt]	Bulb Shape	Manufacturing Processes
	Diameter [mm]	Height [mm]						
LH-51E25C	50.25	25.00	AL6063-T5	Clear Anodized	26.0	3	MR16	Extrusion Machining

** Specifications are subject to change without notice.